

# **TOSHIBA**

---

**BATTERY CABINET SYSTEM  
SINGLE PHASE- 8/10/14/18 kVA**

---

## ***1600EP SERIES***

---

**MANUFACTURED IN THE U.S.A.**

---

### **OPERATION MANUAL**

---

August 2003  
Part# 55416-000

**TOSHIBA**

---

**1600EP SERIES**

**SINGLE PHASE- 8/10/14/18 kVA**

**BATTERY CABINET SYSTEM**

**OPERATION MANUAL**

**TOSHIBA INTERNATIONAL CORPORATION**

**INDUSTRIAL DIVISION**

13131 West Little York Rd., Houston, Texas 77041

## IMPORTANT NOTICE

The instructions contained in this manual are not intended to cover all of the details or variations in equipment, or to provide for every possible contingency to be met in connection with installation, operation, or maintenance. Should further information be desired or particular problems arise which are not covered sufficiently for the purchaser's purposes, the matter should be referred to the local Toshiba sales office.

The contents of this instruction manual shall not become a part of or modify any prior or existing agreement, commitment, or relationship. The sales contract contains the entire obligation of Toshiba International Corporation's UPS Division. The warranty contained in the contract between the parties is the sole warranty of Toshiba International Corporation's UPS Division and any statements contained herein do not create new warranties or modify the existing warranty.

***Any electrical or mechanical modifications to this equipment, without prior written consent of Toshiba International Corporation, will void all warranties and may void UL/CUL listing. Unauthorized modifications also can result in personal injury, death, or destruction of the equipment.***

## UNINTERRUPTIBLE POWER SUPPLY BATTERY CABINET SYSTEM

If additional information or technical assistance is required call Toshiba's marketing department toll free at 1-800-231-1412 or write to: Toshiba International Corporation, 13131 W. Little York Rd., Houston, TX 77041-9990.

Please complete the following information for your records and keep this manual with the equipment:

Model Number: \_\_\_\_\_

Serial Number: \_\_\_\_\_

Date of Installation: \_\_\_\_\_

Inspected By: \_\_\_\_\_

## GENERAL SAFETY INSTRUCTIONS

Warnings in this manual appear in any of four ways:

- 1) *Danger*- The danger symbol is a lightning bolt mark enclosed in a triangle which precedes the 3/16" high letters spelling the word "DANGER". The danger symbol is used to indicate imminently hazardous situations, locations, and conditions which, if not avoided, WILL result in death, serious injury, and/or severe property damage.



**DANGER**

- 2) *Warning*- The warning symbol is an exclamation mark in a triangle which precedes the 3/16" high letters spelling the word "WARNING". The warning symbol is used to indicate potentially hazardous situations and conditions which, if not avoided COULD result in serious injury or death. Severe property damage COULD also occur.



**WARNING**

- 3) *Caution*- The caution symbol is an exclamation mark enclosed in a triangle which precedes the 3/16" high letters spelling the word "CAUTION". The caution symbol is used to indicate potentially hazardous situations and conditions which, if not avoided may result in injury. Equipment damage may also occur.



**CAUTION**

- 4) *Attention warnings*- The attention warning symbol is an exclamation mark enclosed in a triangle which precedes the 3/16" high letters spelling the word "ATTENTION". The Attention warning symbol is used to indicate situations and conditions that can cause operator injury and/or equipment damage.



**ATTENTION**

Other warning symbols may appear along with the *Danger* and *Caution* symbol and are used to specify special hazards. These warnings describe particular areas where special care and/or procedures are required in order to prevent serious injury and possible death:

- 1) *Electrical warnings*- The electrical warning symbol is a lightning bolt mark enclosed in a triangle. The Electrical warning symbol is used to indicate high voltage locations and conditions may cause serious injury or death if the proper precautions are not observed:



- 2) *Explosion warnings*- The explosion warning symbol is an explosion mark enclosed in a triangle. The Explosion warning symbol is used to indicate locations and conditions where molten, exploding parts may cause serious injury or death if the proper precautions are not observed:



## TABLE OF CONTENTS

<b>GENERAL SAFETY INSTRUCTIONS</b> .....	<b>3</b>
<b>TABLE OF CONTENTS</b> .....	<b>4</b>
<b>IMPORTANT SAFETY INSTRUCTIONS</b> .....	<b>5</b>
<b>IMPORTANT SAFETY INSTRUCTIONS</b> .....	<b>6</b>
<b>1.0 Inspection/Storage/Disposal</b> .....	<b>7</b>
1.1 Inspection of the new Battery System.....	7
1.2 Storage of Battery equipment .....	7
1.3 Disposal.....	7
<b>2.0 Precautions</b> .....	<b>8</b>
2.1 Installation Precautions .....	8
2.2 Prestart Precautions.....	8
2.3 Operating Precautions.....	9
<b>3.0 UPS Connections</b> .....	<b>10</b>
3.1 Power Connections .....	10
3.2 Terminal Block details .....	9
3.3 Wire Size and Tightening Torques.....	9
<b>4.0 Connection Instructions and Diagrams</b> .....	<b>11</b>
4.1 Battery Connections .....	11
4.2 14kVA/18kVA illustration .....	11
4.3 Connection Procedure.....	11
4.4 Charger Connection .....	11
<b>5.0 Connection Instructions and Diagrams</b> .....	<b>11</b>
5.1 Battery Connections .....	11
5.2 8kVA/10kVA illustration .....	11
5.3 Connection Procedure.....	11
5.4 Charger Connection.....	11
<b>6.0 Preventive and Scheduled Maintenance / Part Replacement</b> .....	<b>12</b>
6.1 Preventive Maintenance.....	13
6.2 Parts Replacement.....	12
<b>7.0 External Layouts / Dimensions / Shipping Weights</b> .....	<b>14</b>
7.1 External Layouts.....	14
7.2 Dimensions.....	14
7.3 Shipping Weights .....	14
<b>8.0 Emergency Power Off (EPO) Connections</b> .....	<b>15</b>
8.1 Shunt Trip .....	15
8.2 Connection Diagram.....	14

## IMPORTANT SAFETY INSTRUCTIONS SAVE THESE INSTRUCTIONS

This manual contains important instructions for the model **UE31-BC-0650** that should be followed during the installation and maintenance of the Battery System.

The maximum ambient temperature in which a Battery System should be operated is 40°C (104°F).

The nominal battery voltage for the model is as follows:

Model	Voltage
<b>UE31-BC-1825</b>	<b>288VDC</b>

Battery Pack Information:

Battery Packs	Designed for battery acid leakage containment with (6) batteries per pack.
Battery Pack Size HxWxD)Inches(max)	5 x 7.3 x 18.2
Battery Pack Quantity	12
Battery Manufacturer	Energys
Battery Type	NPX-35
Toshiba's Part Number for Battery Pack	51896



**CAUTION** Misuse of this equipment could result in human injury and equipment damage. In no event will Toshiba Corporation be responsible or liable for either indirect or consequential damage or injury that may result from the use of this equipment.



**CAUTION** Do not dispose of the batteries in a fire. The batteries may explode.



**CAUTION** Do not open or mutilate the batteries. Released electrolyte is harmful to the eyes and skin and could also be toxic.



**WARNING** This unit contains sealed lead acid batteries. Lack of preventative maintenance could result in batteries exploding and emitting gasses and/or flame. An authorized, trained technician must perform annual preventative maintenance.



**WARNING** Failure to replace a battery before it becomes exhausted may cause the case to crack, possibly releasing electrolytes from inside the battery, and resulting in secondary faults such as odor, smoke, and fire.



**WARNING** Installation and servicing of batteries should performed by personnel knowledgeable of batteries and the required precautions. Keep unauthorized personnel away from the batteries.

## IMPORTANT SAFETY INSTRUCTIONS



### WARNING

Proper maintenance to the battery system of this unit must be done by a qualified service technician, this is essential to the safety and reliability your UPS system. Refer to service manual.



### DANGER

**A battery can present a risk of electrical shock and high short circuit current.**

The following precautions should be observed when working with batteries.

- 1) Verify that the UPS is off and that the power cord is disconnected from the power source.
- 2) Remove watches, rings or other metal objects.
- 3) Use tools with insulated handles to prevent inadvertent shorts.
- 4) Wear rubber gloves and boots.
- 5) Do not lay tools or metal parts on top of batteries.
- 6) Determine if the battery is inadvertently grounded. If inadvertently grounded, remove source of ground. **Contact with any part of a grounded battery can result in electrical shock.** The likelihood of such shock will be reduced if such grounds are removed during installation and maintenance.
- 7) Verify circuit polarities prior to making connections.
- 8) Disconnect charging source and load prior to connecting or disconnecting terminals.
- 9) VRLA batteries contain an explosive mixture of hydrogen gas. Do not smoke, cause a flame or spark in the immediate area of the batteries. This includes static electricity from the body. Do not attempt to open the batteries in order to add water or sample the specific gravity of the electrolyte. The batteries are valve regulated lead acid type and such servicing is not possible without damaging the battery.  
Use proper lifting means when moving batteries and wear all appropriate safety clothing and equipment.  
Do not dispose of lead acid batteries except through channels in accordance with local, state and federal regulations.

## INSTRUCTIONS IMPORTANTES CONCERNANT LA SÉCURITÉ CONSERVER CES INSTRUCTIONS

Cette notice contient des instructions importantes concernant la sécurité



### ATTENTION

Un battery puet présenter un risque de choc électrique, de brûlure par transfert d' énergie.

### ATTENTION

Por le remplacement, utiliser le même nombre de batteries du modèle suivant.

Model Capacity	Manufacturer	Type	Quantity
UE31-BC-1825	ENERSYS	NPX-35	72



### ATTENTION

L'élimination des batteries est règlementée. Consulter les codes locaux à cet effet.

## 1.0 Inspection/Storage/Disposal

### 1.1 Inspection of the new Battery System:

Upon receipt of the Battery System, a careful inspection for shipping damage should be made.

- 1) Check the unit for loose, broken, bent or otherwise damaged parts. If damage has occurred during shipment, keep all original crating and packing materials for return to the shipping agent. The equipment warranty will not apply to units, which are damaged during shipment.
- 2) Check to see that the rated capacity and the model number specified on the nameplate conform to the order specifications.

### 1.2 Storage of Battery equipment

If the Battery System is to be subjected to long or short term storage the following guidelines should be used.

#### **Avoid:**

- 1) Storage in sites subject to extreme changes in temperature or high humidity.
- 2) Storage in sites subject to exposure of high levels of dust or metal particles
- 3) Storage on inclined floor surfaces or in sites subject to excessive vibration.

#### **Before storing:**

- 1) Charge the system's batteries.
- 2) Place the Battery System's input switch (MCCB-C) in the OFF position.

#### **Storing:**

- 1) Store within a temperature range of -20° to 40° C (-4° to 104° F).
- 2) For best results, store the Battery System in the original shipping container and place on a wood or metal pallet.
- 3) The optimum storage temperature is 21° C (70° F). Higher ambient temperatures cause UPS batteries to need recharging more frequently.
- 4) If stored in an ambient temperature under 20° C (68° F); recharge the batteries every 9 months.
- 5) If stored in an ambient temperature of 20° to 30° C (68° to 86° F); recharge the batteries every 6 months.
- 6) If stored in an ambient temperature of 30° to 40° C (86° to 104° F); recharge the batteries every 3 months.

### 1.3 Disposal

Please contact your state environmental agency for details on disposal of electrical components and packaging in your particular area.

***It is illegal to dump lead-acid batteries in landfills or dispose of improperly.***

Please help our Earth by contacting the environmental protection agencies in your area, the battery manufacturer, or call Toshiba toll-free at (800) 231-1412 for more information about recycling.

## 2.0 Precautions

### 2.1 Installation Precautions



- 1) Install the unit in a well ventilated location; allow at least 10 cm (4 inches) on all sides for air ventilation and maintenance.
- 2) Install the unit in a stable, level, and upright position, which is free of vibration.
- 3) Install the unit where the ambient temperature is within the correct operating range.
- 4) Do not install the Battery System in a location that is subject to high humidity.
- 5) Do not install the unit at sites that are exposed to direct sunlight
- 6) Do not install Battery System in areas which are subject to high levels of contamination by airborne dust, metal particles, or flammable gases.
- 7) Avoid installation near sources of electrical noise. Always make sure that the unit ground is intact to prevent electrical shock and to help reduce electrical noise.
- 8) Do not install where water or any foreign objects/substances may get inside the Battery System.

### 2.2 Prestart Precautions



- 1) Before connecting the Battery System to the UPS verify that the two are compatible by comparing them to the following chart.

UPS Model Number	Battery Cabinet Model Number	Battery Voltage
UE3G2L080C61T	UE31-BC-1825	288VDC
UE3G2L100C61T		
UE3G2L140C61T		
UE3G2L180C61T		



**WARNING** DO NOT attempt to connect if the Model numbers do not match the above chart. This will result in damage to the UPS, the Battery System, or both. Call your Toshiba representative if you should have any questions.

- 2) Before connecting the Battery System to the UPS; move (MCCB2 of the battery system) switch (ON/OFF), on the rear panel (See Sections 4 & 5), to the **OFF** position.



## 2.3 Operating Precautions

- 1) The UPS should not be powered up until the entire operation manual has been reviewed.

## 3.0 UPS Connections

### 3.1 Power Connections

The following illustration details the wiring connections from the power distribution panel (not part of the UPS) to the UPS unit and the Battery unit. This connection diagram is to be used with the following unit: UE31-BC-1825.

**Note:** If paralleling battery cabinets (**maximum 2 cabinets total**) connect CN12A to CN22, CN13A to CN23, and CN14A to CN24.

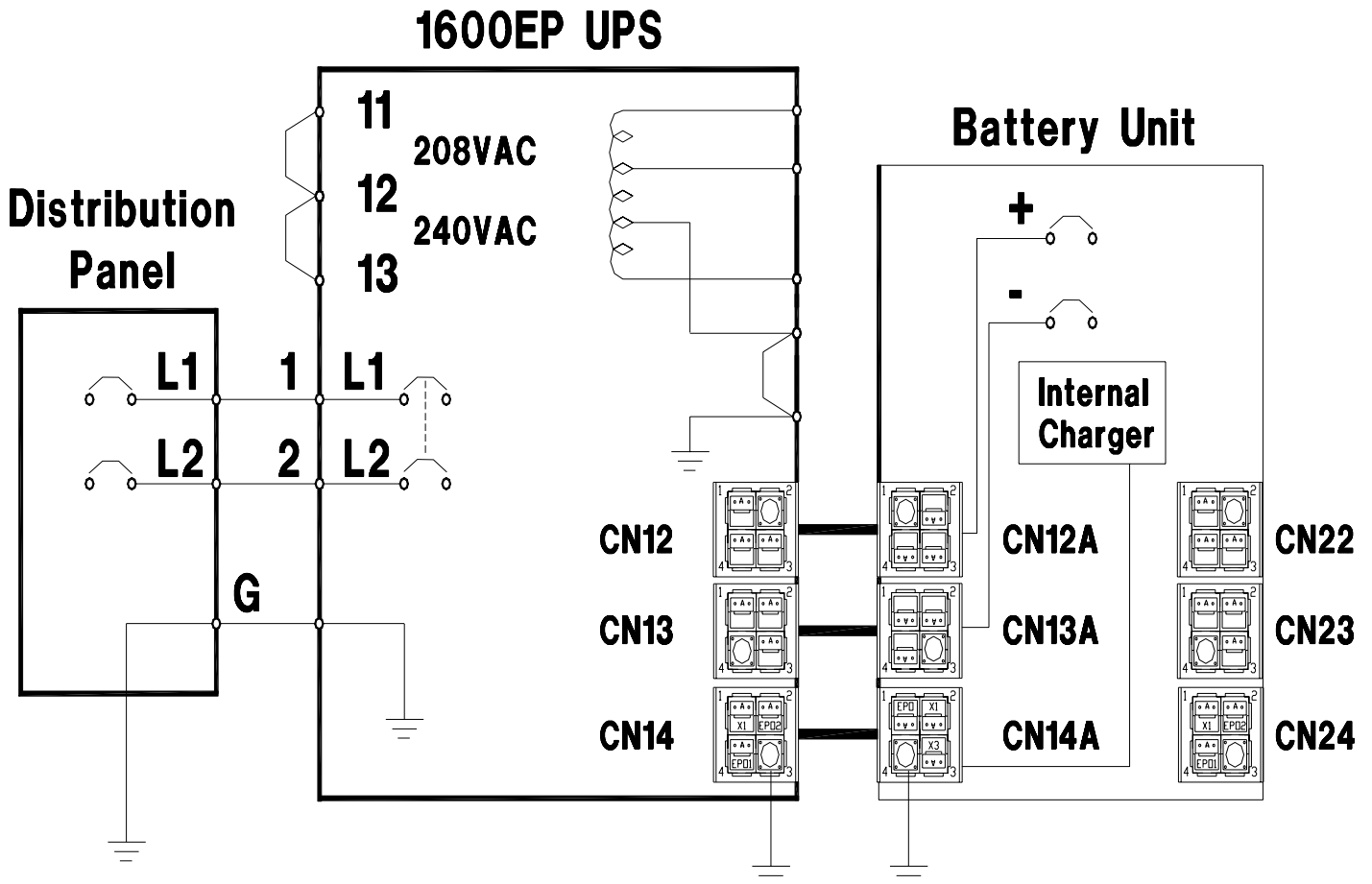

## 4.0 Connection Instructions and Diagrams 14 & 18kVA

### 4.1 Battery Connections



The following illustrations details the wiring connections between the UPS and the Battery Unit.

## DANGER

Contacts are not rated with interrupting capacity. **DO NOT** attempt to connect the UPS to the Battery Cabinet without having the MCCB switch on the rear panel of the Battery Unit, in the **OFF** position.

### 4.2 14kVA/18kVA illustration

The following diagram shows the rear view of a 14kVA / 18kVA UPS and 18kVA Battery Cabinet. **NOTE:** Use only **compatible** cabinets! Refer to page 8.

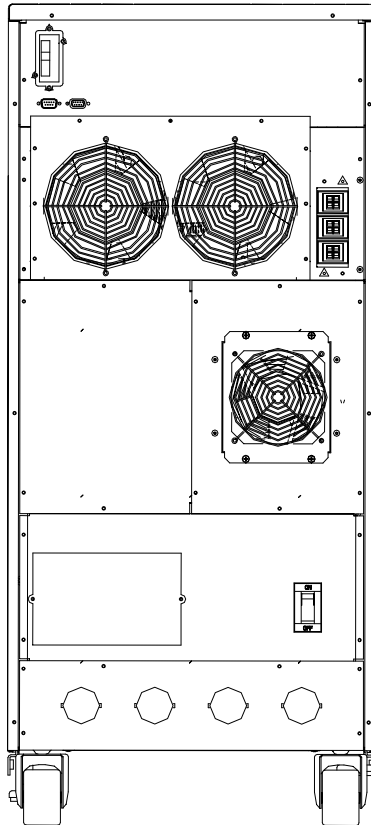

1600EP  
14/18kVA UPS

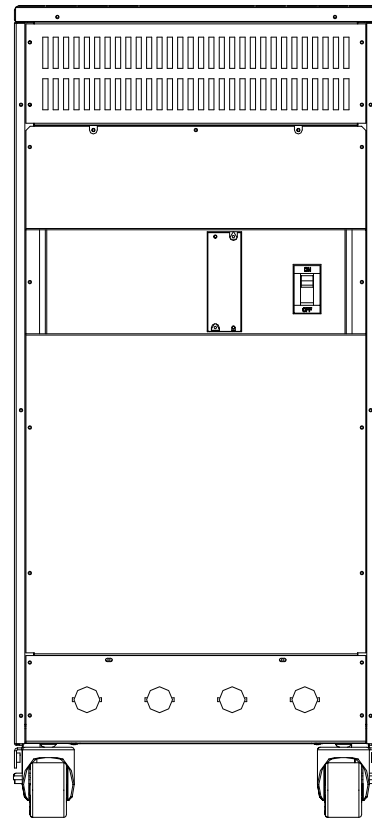

8-18kVA Battery Cabinet

### 4.3 Connection Procedure

- 1) Ensure all power is locked and tagged out.
- 2) Remove the Battery Connector cover mounted on the top of the UPS back panel.
- 3) Plug the DC Connectors of the Battery unit into the DC Connector socket on the UPS unit (see power connections section 3.1).

### 4.4 Charger Connection

Battery Cabinet model UE31-BC-1825 requires 240V connection between the UPS and Battery Cabinet for battery charging. This connection is made from CN14A of the Battery Cabinet to CN14 of the UPS (and CN14A of battery cabinet 2 to CN24 of battery cabinet 1 if paralleling cabinets). **NOTE: Without this connection the battery cabinet will not be able to charge its batteries, thus preventing extended backup time during a power outage.**

## 5.0 Connection Instructions and Diagrams 8 & 10kVA

### 5.1 Battery Connections



The following illustrations details the wiring connections between the UPS and the Battery Unit.

## DANGER

Contacts are not rated with interrupting capacity. **DO NOT** attempt to connect the UPS to the Battery Cabinet without having the MCCB switch on the rear panel of the Battery Unit, in the **OFF** position.

### 5.2 8kVA/10kVA illustration

The following diagram shows the rear view of a 8kVA / 10kVA UPS and 18kVA Battery Cabinet. **NOTE:** Use only **compatible** cabinets! Refer to page 8.

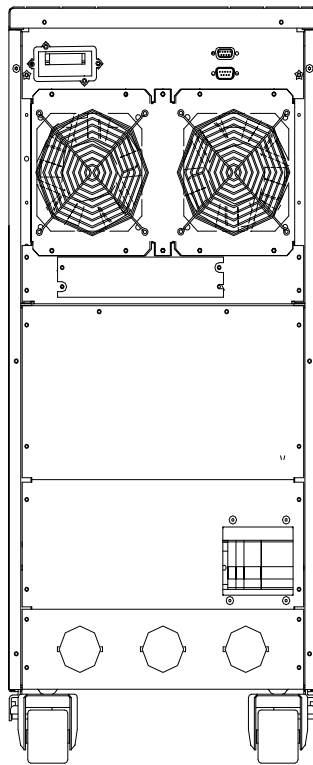

1600EP  
8/10kVA UPS

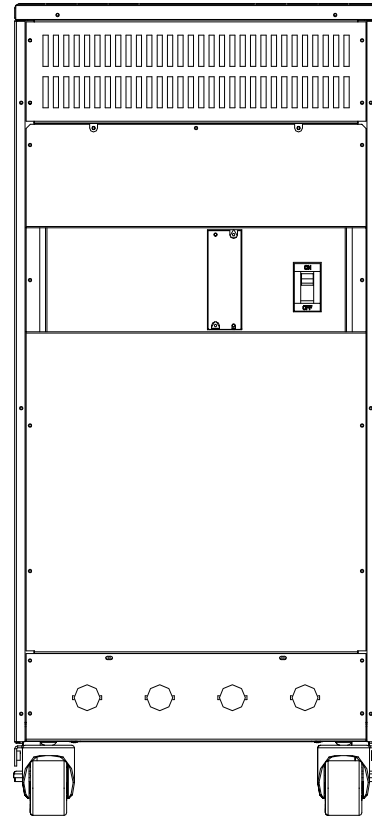

8-18kVA Battery Cabinet

### 5.3 Connection Procedure

- 4) Ensure all power is locked and tagged out.
- 5) Remove the Battery Connector cover mounted on the top of the UPS back panel.
- 6) Plug the DC Connectors of the Battery unit into the DC Connector socket on the UPS unit (see power connections section 3.1).

### 5.4 Charger Connection

Battery Cabinet model UE31-BC-1825 requires 240V connection between the UPS and Battery Cabinet for battery charging. This connection is made from CN14A of the Battery Cabinet to CN14 of the UPS (and CN14A of battery cabinet 2 to CN24 of battery cabinet 1 if paralleling cabinets). **NOTE: Without this connection the battery cabinet will not be able to charge its batteries, thus preventing extended backup time during a power outage.**

## 6.0 Preventive and Scheduled Maintenance / Part Replacement

### 6.1 Preventive Maintenance

Toshiba's 1600 Plus Series of UPS battery cabinets have been designed to provide years of trouble-free operation requiring a minimum of preventive maintenance.

The best preventive measure that the battery cabinet user can take is to keep the area around the unit, particularly the air inlet vents, clean and free of moisture and dust accumulations. If the atmosphere of the installation site is very dusty, use a vacuum cleaner to periodically remove dust accumulations from the air inlet vents. Schedule authorized service centers to perform internal parts inspections annually.



### CAUTION

Before performing any maintenance, the technician should become familiar with and follow the important safety instructions located on pages 3, 5 and 6.



### WARNING

Proper maintenance of the battery system of this unit by a qualified service technician is essential to the safety and reliability of your battery cabinet system. Refer to service manual.

### 6.2 Parts Replacement

The following list shows intervals for periodic maintenance and replacement of certain UPS parts.

- 1) Batteries: VRLA batteries are maintenance free with respect to electrolyte only. The charging voltage, temperature, performance and connection resistance must be checked periodically. Necessary corrective actions must be made in order to assure safe reliable power is supplied by the battery cabinet. The aforementioned items affect the life of batteries, so replacement should be once every 3 to 5 years as a minimum. All of the batteries must be replaced at the same time.

#### Monthly Maintenance

- A. Visual Checks
  - 1) Leakage
  - 2) Corrosion on positive terminal
- B. Check battery temperature at the negative terminal
- C. Measure and record the system float charging voltage.
- D. Measure and record the individual unit's float charging voltage.

#### Semi-Annual maintenance

- A. Repeat the monthly checks.
- B. Perform a 10-second high rate (e.g. 100 amp) load test on the individual batteries.
- C. Re-torque all inter-battery connecting hardware (if applicable).
- D. Perform inter-battery connector resistance checks.

## 7.0 External Layouts / Dimensions / Shipping Weights

### 7.1 External Layouts

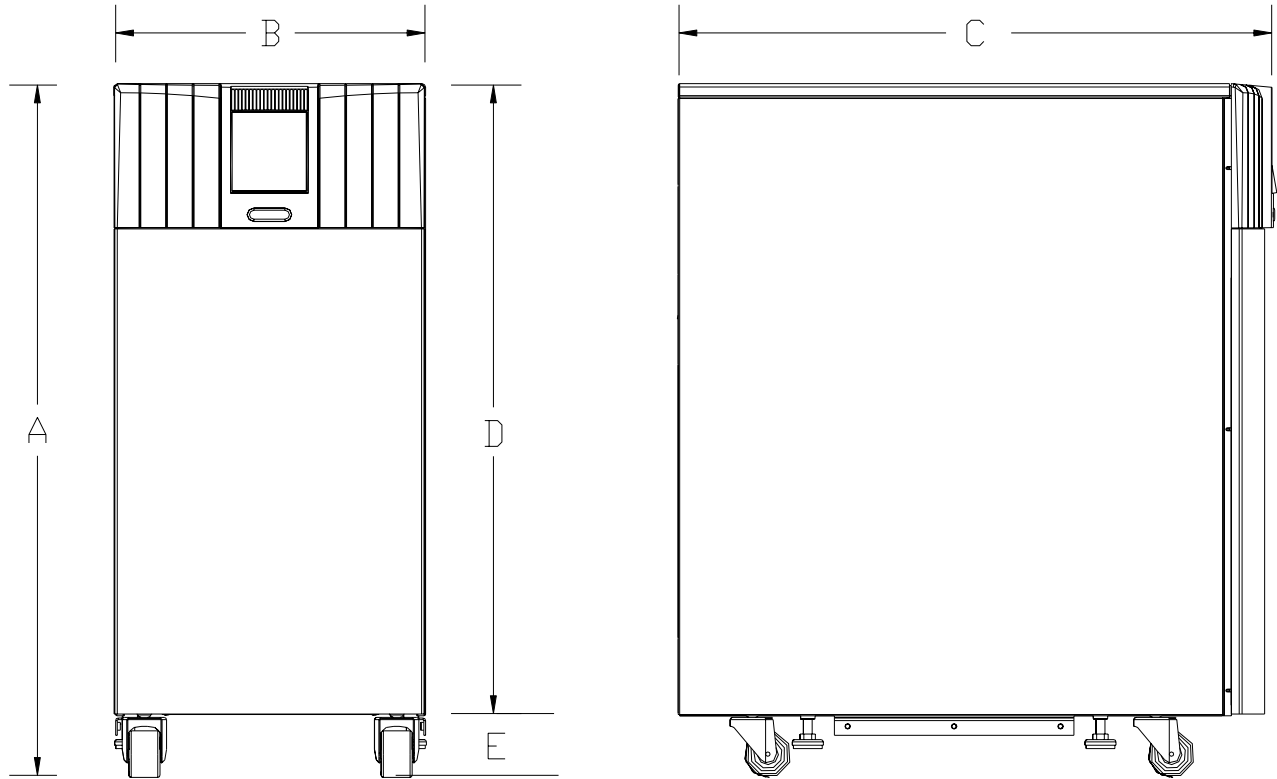

### 7.2 Dimensions

Model	A	B	C	D	E
UE31-BC-1825	39.1 IN. (992 MM)	17.5 IN. (445 MM)	34.8 IN. (885 MM)	35.6 IN. (904 MM)	3.47 IN. (88 MM)

### 7.3 Shipping Weights

Model	Pounds	Kilograms
UE31-BC-1825	620 lbs.	282 kg

## 8.0 Emergency Power Off (EPO)

### 8.1 Shunt Trip

A shunt trip for the DC breaker on the battery cabinet is provided. This device is operated with an applied voltage of 120VAC (**supplied from the UPS**). When this voltage is applied, the shunt trip will cause the breaker to switch to the OFF position disabling the battery cabinet.

**7.2 NOTE:** The EPO is achieved by completing the circuit between 14 & 15 on terminal block TB1 of the UPS. By completing the circuit, the shunt trip will cause the breaker on the battery cabinet as well as the one on the UPS to switch to the OFF position disabling the UPS and battery cabinet.

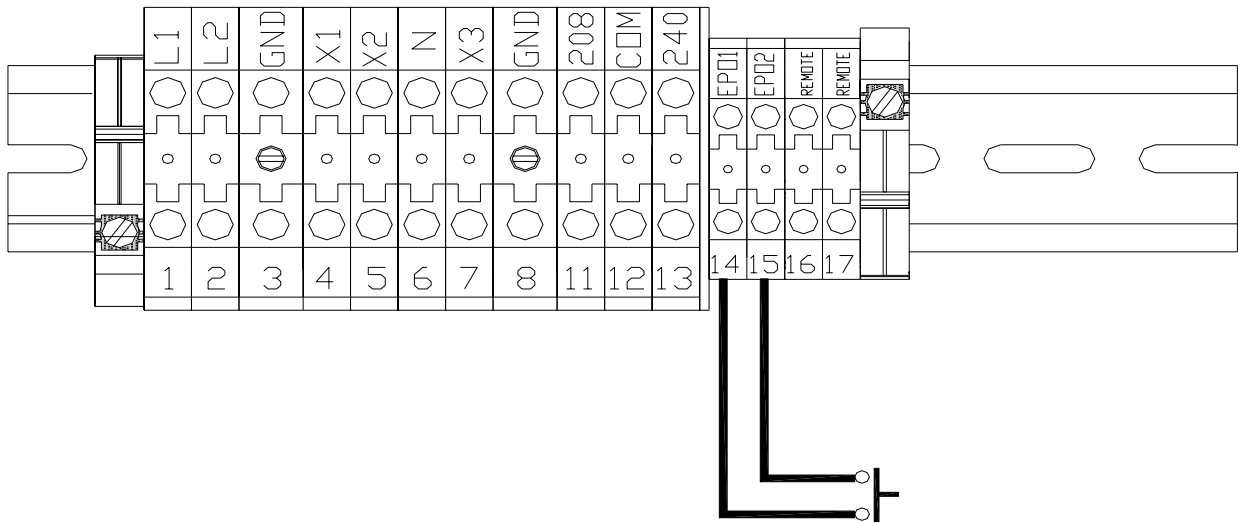

Terminal Block TB1 on the 1600EP UPS